









CABLE RELEASE WITH HOLDER FOR 3RU2 SIZE
S00...S2



Figure similar

General technical data:		
product brandname		SIRIUS
Product designation		cable release with holder for RESET
Design of the product		400 mm long
Size of overload relay		S00, S0
Ambient temperature		
• during storage	°C	-50 ... +80
• during operation	°C	-20 ... +70
Installation/ mounting/ dimensions:		
Length	mm	400
Mounting diameter	mm	6.5
Certificates/ approvals:		

General Product Approval	Declaration of Conformity	Test Certificates	Shipping Approval
 CSA	 UL	 EG-Konf.	Type Test Certificates/Test Report  ABS  BUREAU VERITAS

Shipping Approval	other
 PRS	 RINA
 RMRS	Environmental Confirmations Confirmation

Further information

Information- and Downloadcenter (Catalogs, Brochures,...)

<http://www.siemens.com/industrial-controls/catalogs>

Industry Mall (Online ordering system)

<http://www.siemens.com/industrymall>

Cax online generator

<http://support.automation.siemens.com/WW/CAXorder/default.aspx?lang=en&mlfb=3RU2900-1B>

Service&Support (Manuals, Certificates, Characteristics, FAQs,...)

<https://support.industry.siemens.com/cs/ww/en/ps/3RU2900-1B>

Image database (product images, 2D dimension drawings, 3D models, device circuit diagrams, EPLAN macros, ...)

http://www.automation.siemens.com/bilddb/cax_de.aspx?mlfb=3RU2900-1B&lang=en

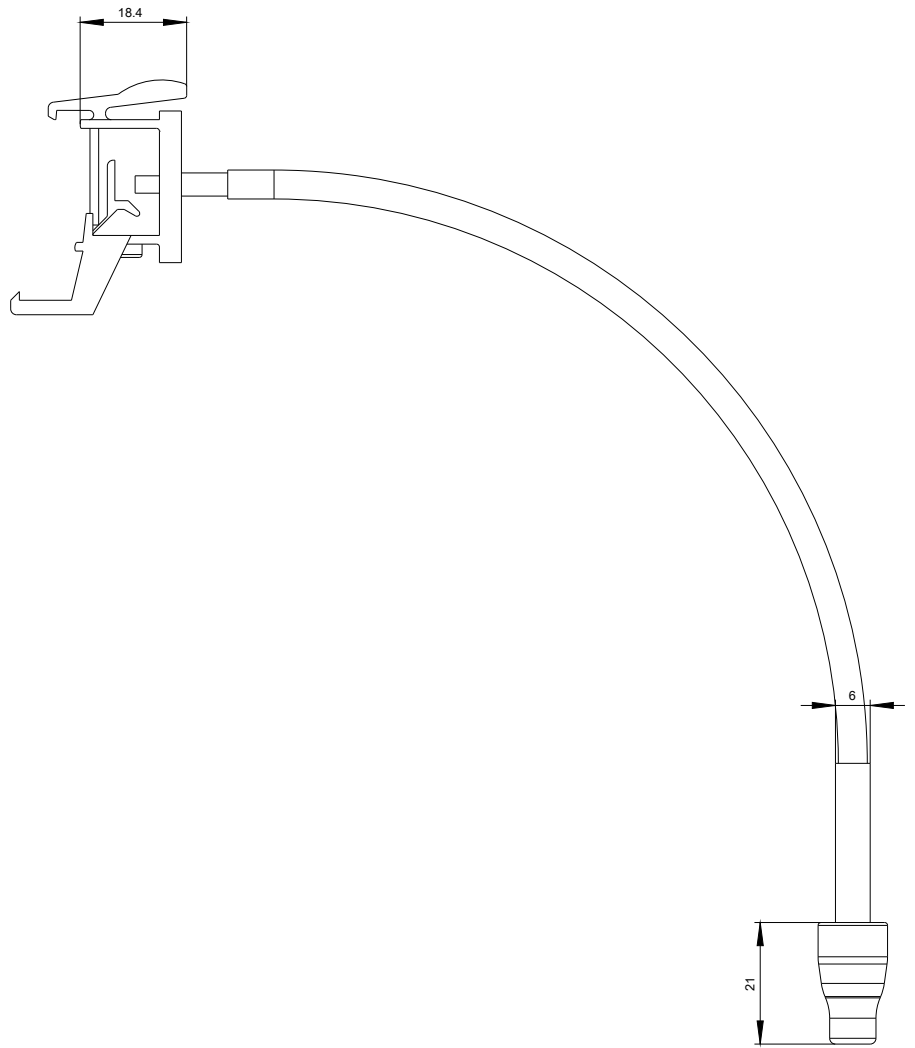
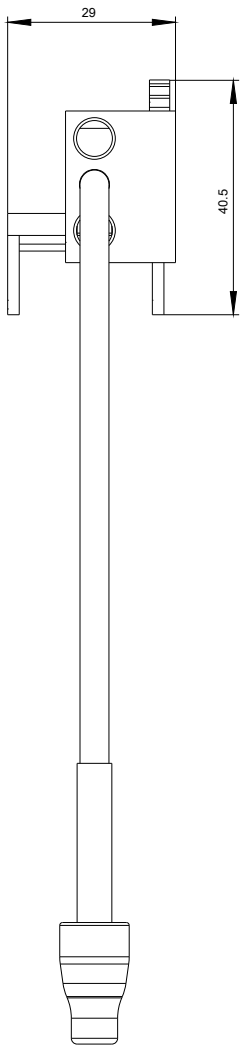

last modified:

06/20/2017